

Features

- Low-threshold design for easy entry and exit.
- Covered drain with removable cover.
- Single threshold for alcove installation.
- Center drain.
- Coordinates with other products in the Archer collection.

Material

- Acrylic.

Recommended Products/Accessories

- K-9132 Shower Drain
- K-1733 9 kW Steam Generator
- K-702206-G73 Frameless Sliding Shower Door
- K-702207-L Frameless Sliding Shower Door
- K-706009-D3 Frameless Sliding Shower Door
- K-706009-L Frameless Sliding Shower Door
- K-706012-L Frameless Sliding Shower Door
- K-706013-L Frameless Sliding Shower Door
- K-706015-D3 Frameless Sliding Shower Door
- K-706015-L Frameless Sliding Shower Door
- K-706019-L Frameless Sliding Shower Door
- K-23726 Drain treatment
- K-23732 Tub & shower cleaner



Codes/Standards









- CSA B45.5/IAPMO Z124
- ASTM E162
- ASTM E662

KOHLER® Plastic Baths and Receptors Lifetime Limited Warranty

See website for detailed warranty information.

Available Colors/Finishes

Color tiles intended for reference only.

Color	Code	Description
	0	White
	96	Biscuit
	47	Almond
	NY	Dune
	95	Ice™ Grey
	33	Mexican Sand™
	58	Thunder™ Grey
	7	Black Black™

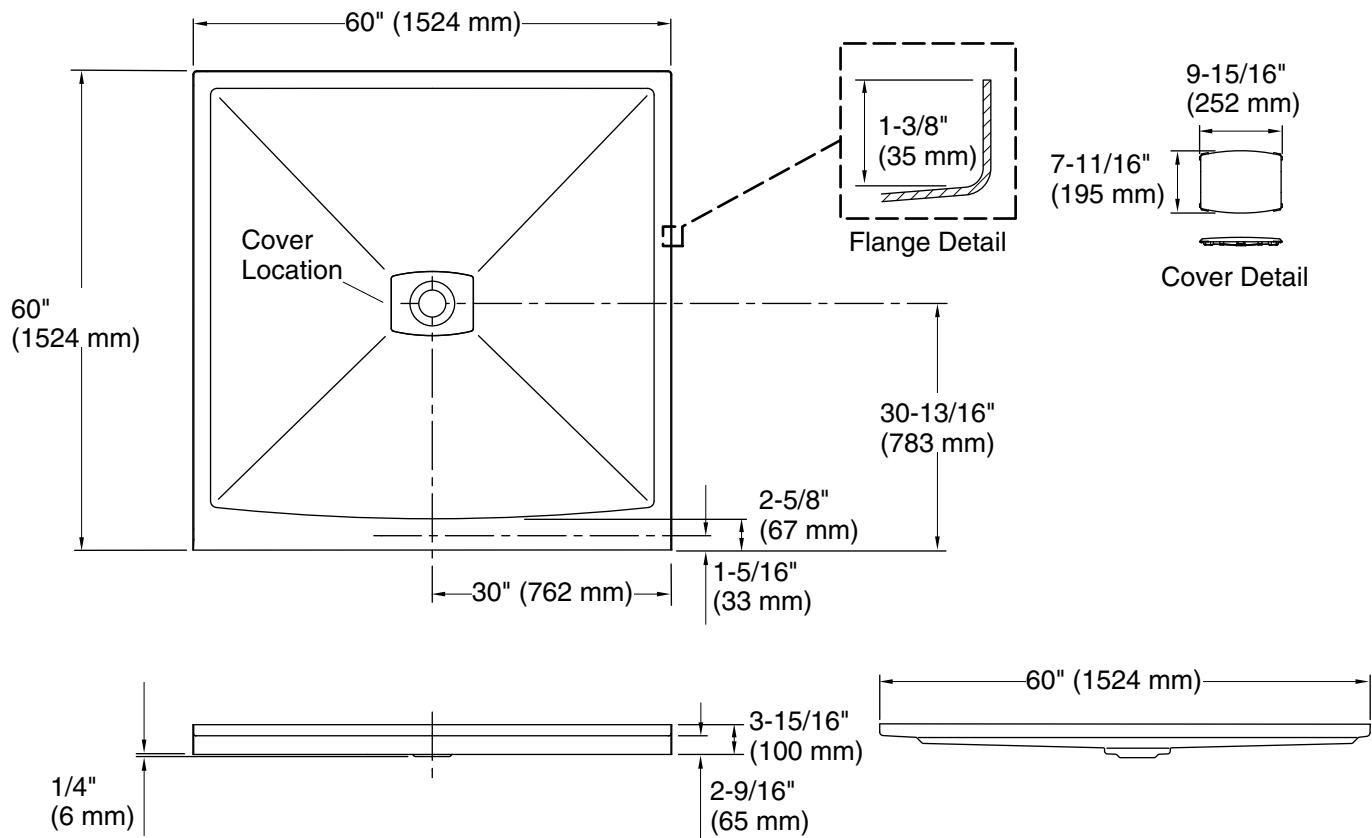

Technical Information

All product dimensions are nominal.

Installation:	Three-wall alcove
Drain location:	Center
Weight:	83 lbs (37.6 kg)
Minimum floor load:	15 lbs/ft ² (73.2 kg/m ²)

Notes

Measure your actual product for rough-in details.

Install this product according to the installation instructions.

Shimming may be required to level the fixture.

Shimming may be required between the stud frame and the fixture.

Stud opening tolerance is + 1/4" (6 mm), - 0" (0 mm).